



macromedics

SOLUTIONS IN RADIOTHERAPY

Product Catalogue

Version 6.1





<p>3 Contents</p> <p>5 Vision and innovation</p> <p>6 DSCP - Disease Specific Care Platform</p> <p>OmniCouch™ 8</p> <p>OmniBoard™ 14</p> <p>MultiBoard™ 21</p> <p>MRidian FluxBoard™ Base 23</p> <p>EAMIS Lite™ 24</p> <p>DSCP Accessories 26</p> <p>30 Head & Neck</p> <p>SSPS® 30</p> <p>DSPS® 32</p> <p>Head & Neck baseplates 34</p> <p>IMRT & Tilting baseplates 35</p> <p>MaxSupport™ 36</p> <p>37 Thermoplastic Masks</p> <p>DSPS® & SSPS® 38</p> <p>MacroCast™ 41</p> <p>MacroBath™ 43</p> <p>44 Breast & Thorax</p> <p>BreastBoard SX™ 44</p> <p>BreastBoard LX™ 45</p> <p>ThoraxSupport™ 46</p> <p>EagleBoard™ 47</p>	<p>48 Pelvic, Abdomen & Extremities</p> <p>KneeSupport™ 48</p> <p>FeetSupport™ 49</p> <p>LEPS™ 50</p> <p>Pelvic Prone Board™ 51</p> <p>LEX-Ultra™ 52</p> <p>UniqFix™ 53</p> <p>54 Miscellaneous</p> <p>Couchtops 54</p> <p>CouchStrips™ 55</p> <p>Vacuum Cushions 56</p> <p>ExaFlex™ & thermoplastic bolus 57</p> <p>Products for use in MR 58</p> <p>59 Product List</p> <p>63 Quality & regulatory information, references</p>
---	--



MacroMedics® = Vision + Innovation

Our open and direct communication with radiotherapy professionals allows us to anticipate new trends in treatment techniques. This enables us to develop new ideas and visions for unique, high-end quality products and solutions, using modern components, materials and advanced manufacturing techniques.

The focus of our design approach is to create an efficient and effective radiotherapy treatment, based on optimal positioning of the patient. For this we see patient comfort as a crucial element in the set-up and treatment process.

Our individualized approach to the patient, combined with dedicated and innovative positioning products, will provide optimal control of treatment processes and workflow efficiencies.



macromedics

SOLUTIONS IN RADIOTHERAPY



An example of Vision + Innovation coming together is MacroMedics' Double Shell Positioning System DSPS®, which was nominated for the Dutch Design Award 2013. With this truly innovative positioning system, MacroMedics managed to reach the finalists group for this award.

DSCP™

Disease Specific Care Platform

MacroMedics offers a unique and innovative approach on Disease Specific Care by introducing a contemporary and comprehensive product line dedicated for standard as well as high precision radiotherapy treatment such as hypo fractionation and arc therapy.

The concept of the Disease Specific Care Platform (DSCP) is based on positioning optimization of designated treatment areas and organs by making use of a platform consisting of a number of specific treatment boards or couchtops combined with an extensive set of sophisticated modular positioning accessories.

With these accessories a comfortable full-body support for the patient is created while focusing on the treatment area with advanced positioning products, explicitly designed for the specific treatment area. With only lightweight accessories to attach, there is no need to longer lift heavy, bulky positioning boards on and off the treatment table. The quick accessory attachment results in reduced set-up times and a significant optimization of the workflow for everyday as well as high precision treatment. This makes the Disease Specific Care Platform an excellent product of choice.

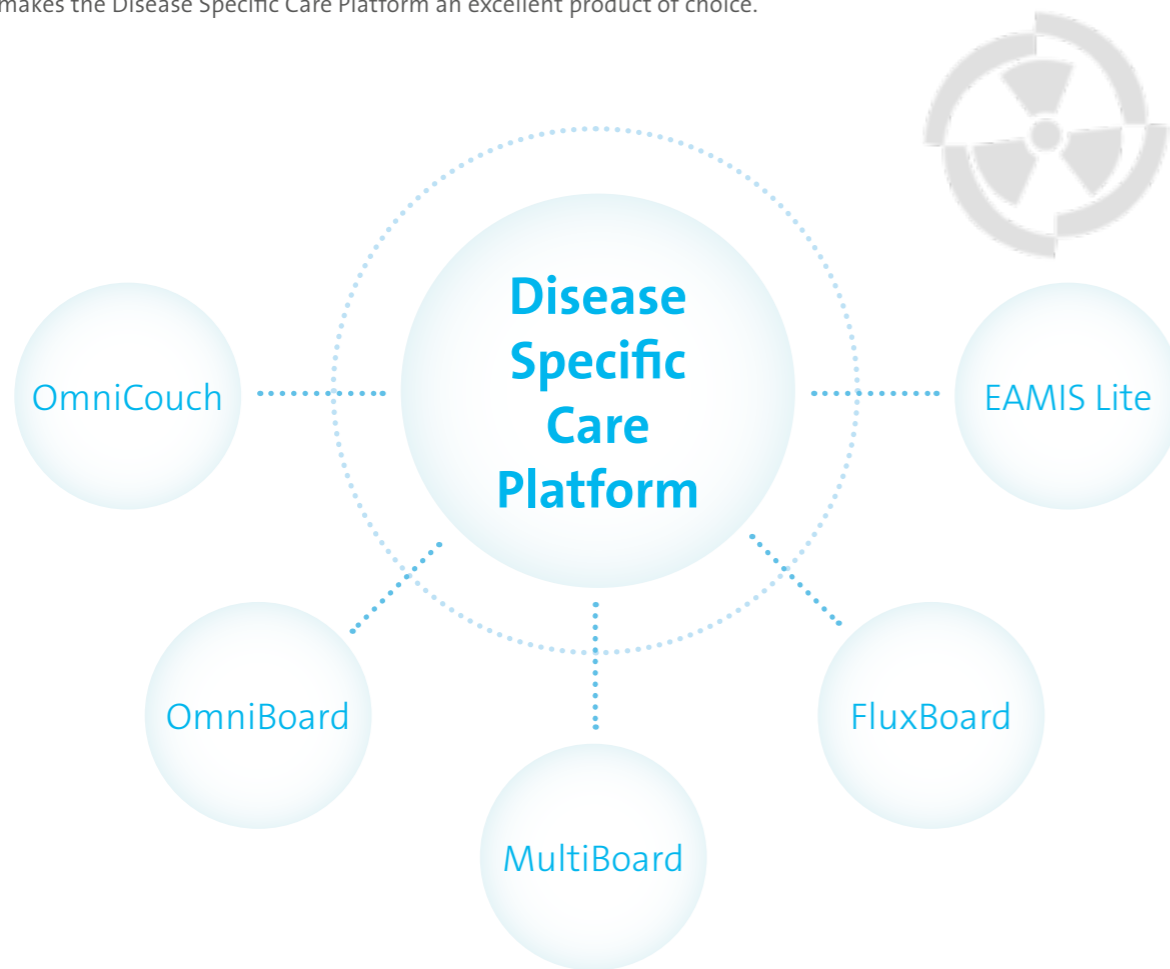

AC RAD MEDICAL
CONSULT & SERVICE

OmniCouch™

Disease Specific Care Platform

The evolution continues... The MacroMedics® OmniCouch is the latest addition to the MacroMedics Disease Specific Care Platform (DSCP). It offers new innovative solutions in the travel range, allowing to position patients for most common treatments without the necessity of changing modules for adjusting the table length. Modular and easily attachable treatment accessories provide flexibility and a quick change between different patient set-ups.

Modular accessories

The OmniCouch is a complete all-in-one solution with a wide range of accessories to provide optimized set-ups for various disease sites. Due to the modularity of the system, the OmniCouch can be set-up quickly for the next patient, supporting an efficient workflow. Compact size and light weight make the ergonomic accessories easy to handle.

Features

- Extended travel range
- Modular accessories
- Uniform patient set-up on all modalities

A full range of SBRT accessories transforms the OmniCouch quickly into a versatile SBRT platform.



For Breast Treatments, lightweight modules are available that can be attached to the OmniCouch in just seconds.



AC RAD MEDICAL
CONSULT & SERVICE

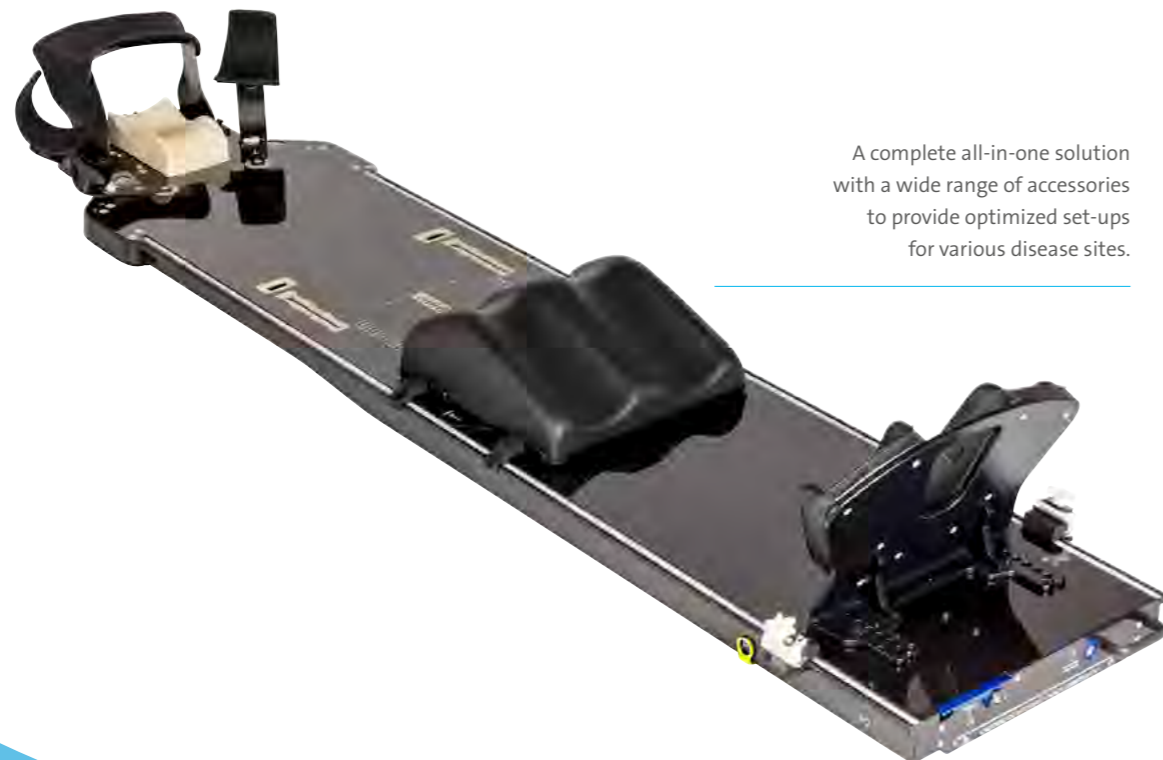

A complete all-in-one solution with a wide range of accessories to provide optimized set-ups for various disease sites.



3-point RealEase™ mask

For Head, Neck and Shoulders the superior OmniCouch section has an integrated design for adaption of the dedicated devices and thermoplastics.



5-point RealEase™ mask

P1 - position



P2 - position



Extended travel range

The OmniCouch is a 'one-piece couchtop' that can be displaced longitudinally with a high-end mechanical sliding system, offering an optimized travel range for various treatment areas.

With an effortless displacement between the 2 discrete longitudinal positions, the OmniCouch will be customized for the required treatment setting.

Uniform patient set-up on all modalities

The OmniCouch provides uniformity to your department by offering the same set-up on CT, PET-CT and linac. This allows a smooth transition from imaging to treatment. It also provides you with the flexibility to transfer the patient to another room in case of machine downtimes.



The OmniCouch provides uniformity to your department by offering the same set-up on CT, PET-CT and linac.



AC RAD MEDICAL
CONSULT & SERVICE



OmniCouch on linac



OmniCouch on CT

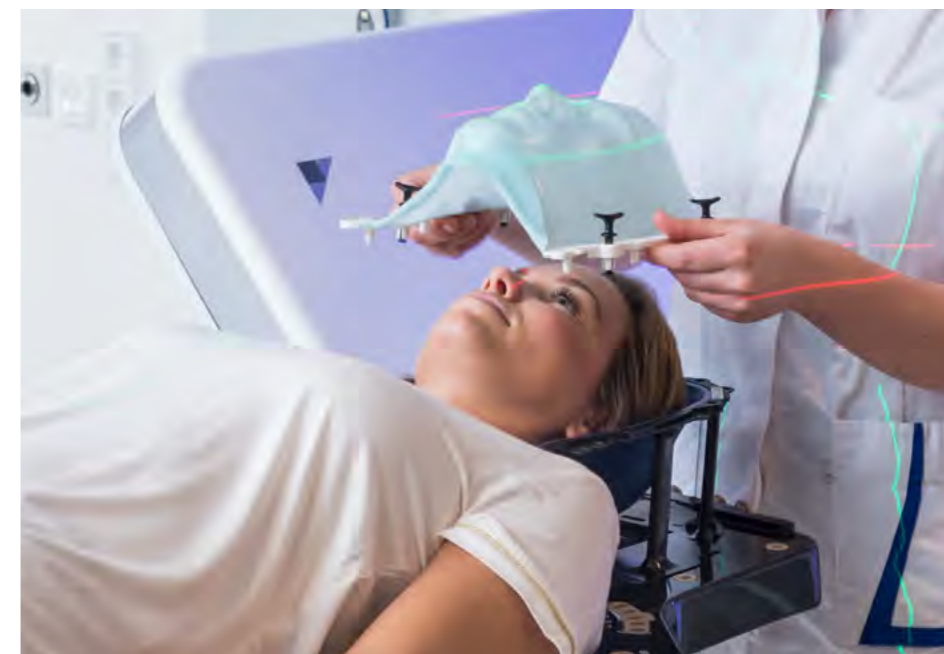

Ready for high precision

With the MacroMedics Double Shell mask system attached, the OmniCouch is ready for high precision SRS/SRT Treatments.

The OmniCouch provides uniformity to your department by offering the same set-up on CT, PET-CT and linac.



Patient comfort
is patient control

AC RAD MEDICAL
CONSULT & SERVICE



OmniBoard™

Disease Specific Care Platform

Throughout the past years, the OmniBoard has become one of the most successful products in the MacroMedics® product range. Our customers value its infinite possibilities for patient set-ups for various disease sites.

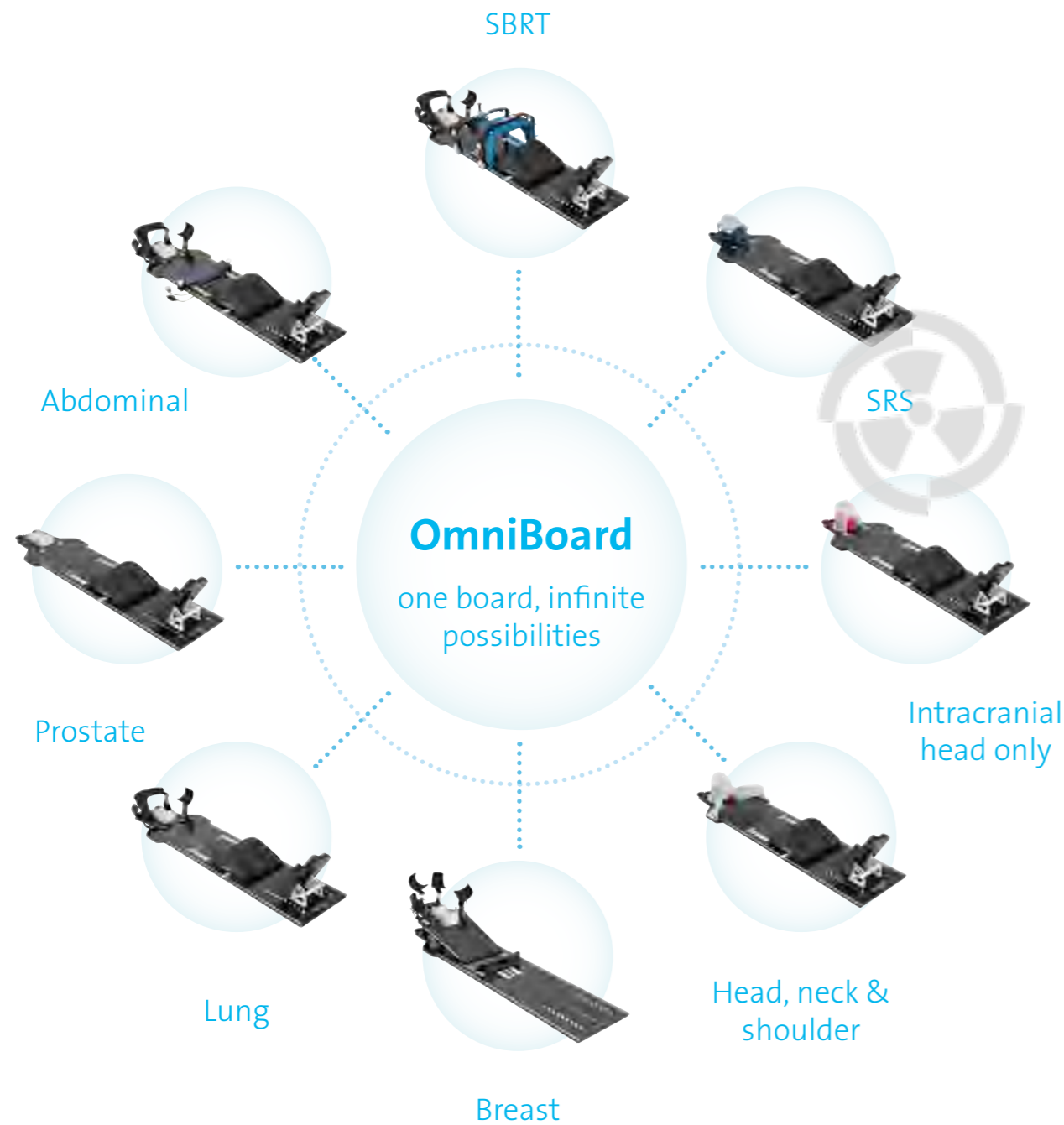

The MacroMedics OmniBoard All-In-One patient positioning system is the only all-in-one solution designed specifically with therapists in mind to optimize the things they care about most: **Efficiency, Versatility, Reproducibility and Safety.**



Efficiency

- All-in-one solution
- Transition efficiency / speed
- Cost efficiency - eliminate redundant purchases
- Storage efficiency



Versatility

- All-in-one solution
- Modular components = eliminates redundancies



Reproducibility

- Indexed set-up modules
- Set-up sheets



Safety

- Eliminates need to lift heavy, stand-alone set-up boards

AC RAD MEDICAL
CONSULT & SERVICE

OmniBoard™

Disease Specific Care Platform

The OmniBoard offers a unique Breast Treatment Module that is extremely light. With a weight of only 2,8 kg, the SX Breast Treatment Module is considerably lighter to lift than any stand-alone breastboard.

Latest addition to the range is the LX Breast Treatment Module which is very similar to our successful stand-alone BreastBoard LX (see page 45). It offers various adjustment possibilities for positioning of arms and head.



LX module



SX module

With our Double Shell mask system attached, the OmniBoard is ready for high precision SRS/SRT treatments. See table on page 33 for accuracy details. The OmniBoard can be extended off the cranial end of the couchtop until the dotted line, providing full freedom for treatments in the head & neck area.

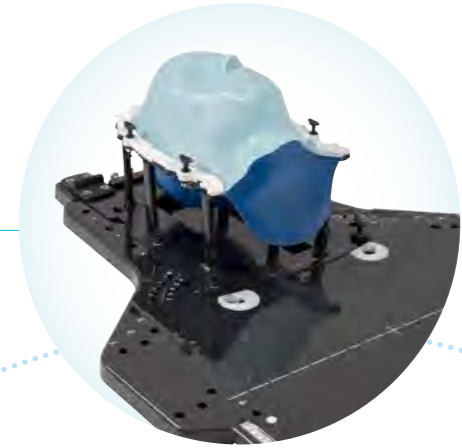

AC RAD MEDICAL
CONSULT & SERVICE



Inclination
SX Module:
5°, 10° or 15°
LX Module:
5°, 7,5°, 10°, 12,5° or 15°

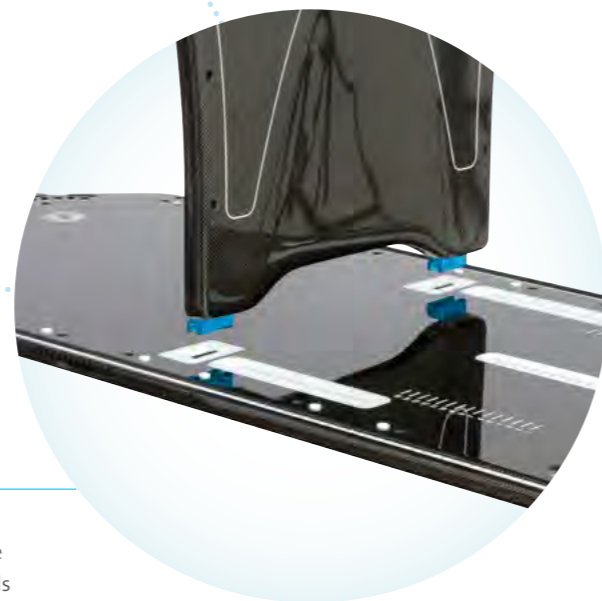

Extremely lightweight Breast Treatment Module can be removed in seconds



The OmniBoard can not only be used for a large range of standard treatments. A full range of SBRT accessories transform it quickly into a versatile SBRT platform.

Patient comfort
is patient control

AC RAD MEDICAL
CONSULT & SERVICE



OmniBoard™

Decision tree



Please note
Additional accessories, as shown on DSCP Accessories pages 26-27, can be added to complete your configuration.

MacroMedics® and our distributors will be pleased to offer further advice on the best configuration for your needs.

CONFIGURE YOUR OMNIBOARD

Please also select CouchStrips, see page 55 and MaxSupports, see page 36

MultiBoard™

Disease Specific Care Platform

The MultiBoard™ is a compact "All in One" patient positioning solution. The modular accessories offer a vast range of different set-up options for adults and pediatrics. They allow a quick transition from one set-up to another, supporting an efficient workflow in the department.

AC RAD MEDICAL
CONSULT & SERVICE

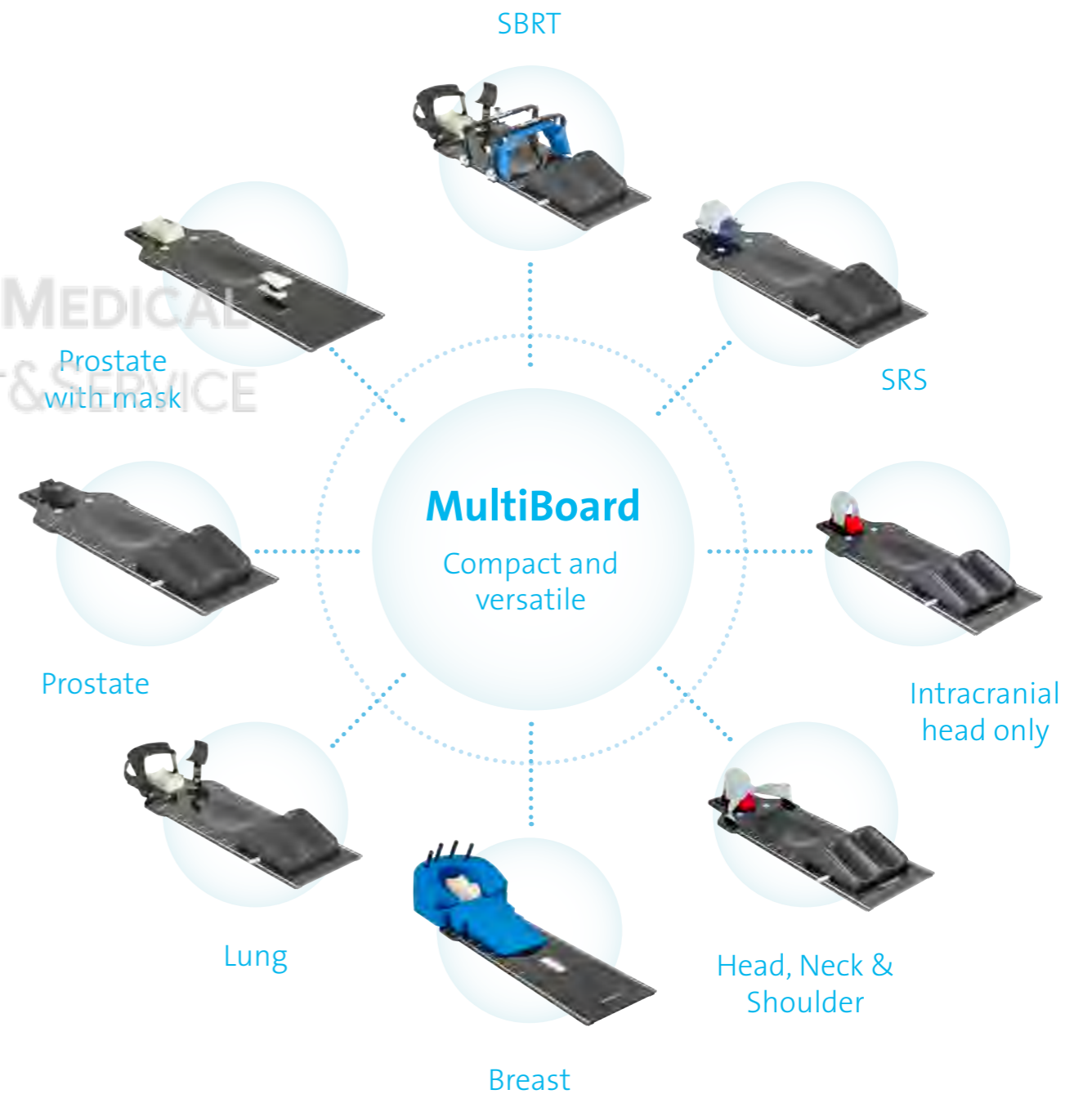

MultiBoard™

Disease Specific Care Platform

The MultiBoard is a versatile Modular Treatment Board and part of MacroMedics® Disease Specific Care Platform (DSCP).

This compact “All in One” patient positioning solution offers flexibility and allows quick and efficient patient set-up through indexed steps. The MultiBoard Base is anatomically shaped for patient comfort and can be indexed on the couchtop where it can remain during daily treatment. It can be used with a vast range of thermoplastic masks for head & neck, also for pediatrics, as well as thorax and pelvic masks. Combined with the modular MacroMedics positioning products, the MultiBoard becomes a dedicated device for head & neck, lung & thorax, liver & lower abdomen as well as SBRT treatments.

Features

- “All in One” solution for optimized workflow
- Lightweight carbon fiber construction for optimized dosimetry¹
- Quickly transformed into SBRT platform
- Indexable
- An MR safe version is available

FluxBoard™

Disease Specific Care Platform

The MacroMedics® FluxBoard is part of the Disease Specific Care Platform (DSCP) and supports comfortable positioning and reproducibility for patient set-up on the **VIEWRAY® MRIDIAN®** System.

The FluxBoard is a comfortable and fully individually-adjustable solution that has been designed specifically for the MRIdian system to optimize the patient positioning area. It extends the length available for patient positioning, ensuring that also tall patients can be positioned comfortably. The shape of the FluxBoard and its accessories is optimized for coil placement. The FluxBoard allows you to make the most out of the treatment possibilities that the MRIdian system is offering you.

New

A head & neck module is now available, offering the comfort and accuracy of our Double Shell masks combined with dedicated coil positioning.

Features

- Comfortable positioning and reproducibility
- Optimized patient positioning area to also position tall patients comfortably
- Shape and accessories optimized for coil placement



AC RAD MEDICAL
CONSULT & SERVICE



Head & neck module

New

EAMIS Lite™

Disease Specific Care Platform

The EAMIS Lite is part of the of MacroMedics® Disease Specific Care Platform (DSCP). This extremely compact and lightweight rail system offers various set-up possibilities for high precision stereotactic treatments. It is a state of the art solution for lung & thorax, liver and lower abdomen treatments.

Features

- Extremely compact and lightweight
- Easy handling
- Easy attachment of SBRT Secure Arches
- Respiratory suppression plate to minimize respiratory motion
- Abdominal vacuum cushion to further stabilize set-up
- Indexable
- An MR safe version is available



EAMIS Lite - our most compact solution for SBRT



AC RAD MEDICAL
CONSULT & SERVICE



Ready for high precision
MacroMedics® SBRT
Secure Arches and other accessories can be attached to our DSCP platform with millimeter precision and can be quickly adjusted in height in indexed steps.

DSCP Accessories

Disease Specific Care Platform

A vast range of accessories offers a variety of possibilities for reproducible set-up.

SBRT Secure Arches

SBRT Secure Arch, size XS	123700	SSA-XS
SBRT Secure Arch, size S	123600	SSA-S
SBRT Secure Arch, size M	123500	SSA-M
SBRT Secure Arch, size L	123400	SSA-L



SBRT Secure Arches offer indexed height adjustment and quick attachment of accessories like abdominal vacuum cushions or Respiratory Suppression Plate

Abdominal vacuum cushions

Abdominal vacuum cushion, size S	123450	EA-VS
Abdominal vacuum cushion, size XL	123470	EA-VXL

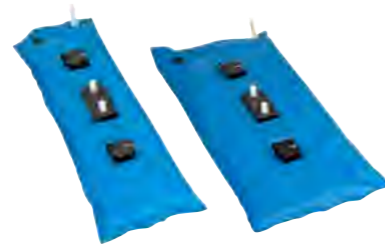

Respiratory Suppression Plate

Respiratory Suppression Plate for SBRT Secure Arches, size S	123530	EA-BPPS
Respiratory Suppression Plate for SBRT Secure Arches, size L	123540	EA-BPPL



Respiratory Suppression Belt

Respiratory Suppression Belt	126270	DSCP-CB
------------------------------	--------	---------



Arm Supports

Rigid upper arm support, set of 2	125300	UTB-RAS
Height adjustable arm support with flexible high armcup fit for OmniBoard, MultiBoard, BreastBoard SX, set of 2	125320	DSCP-AAS



Rigid



Height adjustable

Handgrips

Handgrips for shoulder retraction, set of 2	126260	DSCP-HG
---	--------	---------



Cushion

Cushion to cover FeetSupport pins	115260	CUSFP
-----------------------------------	--------	-------



Vacuum Cushion Positioning System

Positioning System for vacuum cushions on RealEase OmniBoard or MultiBoard, set of 2	173520	UTB-VCPSRE
--	--------	------------



New

MR Body Coil Holder Secure Arch

MR Body Coil Holder Secure Arch	176010	SA-CH
---------------------------------	--------	-------



MR Body Coil Holder Arch

New





AC RAD MEDICAL
CONSULT & SERVICE



SSPS®

Single Shell Positioning System

The MacroMedics® Single Shell Positioning System (SSPS®), is a system that offers increased stability for head, neck & shoulder positioning. Based on an accurate mechanical principle, the SSPS distinguishes itself from existing head, neck & shoulder systems and presents a completely new approach for increased set-up stability in the head & neck region.

With current thermoplastic mask systems the mask material can become overstretched. This may result in thin material and thus less stable patient set-up. The solution: the Single Shell Positioning System (SSPS) that focuses on the patient's facial contours which are relevant for a precise repositioning, in combination with a very rigid and direct connection to the baseplate.

The ultra-light and extremely rigid cradle can be connected to the baseplate in seconds and forms a strong and rigid link between mask and baseplate. The mask is limited to the relevant boundaries of the patients facial contours. As it only needs to be stretched towards the cradle rim, the mask remains compact and will not be overstretched. This will clearly contribute to the stability of the patient set-up. The SSPS differentiates itself by an improved mechanical approach resulting in better rigidity in the positioning system as a whole. It combines easy handling with increased set-up stability.
Patent pending

Features

- Rigid carbon fiber cradle for stable mask set-up
- Compact mask without overstretch
- Special non-shrinking mask material
- Available for various baseplates

Current situation

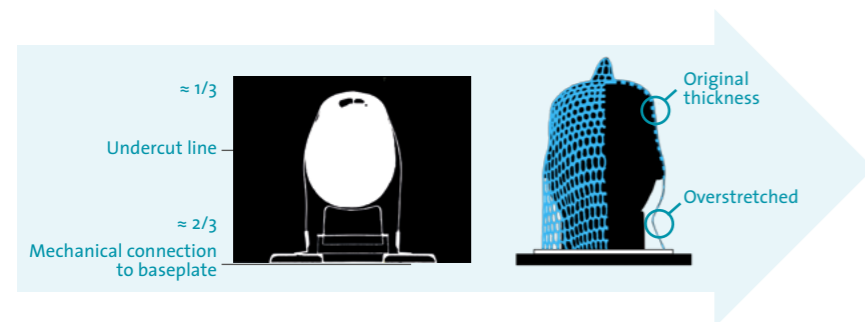

New: ultimate mask stability



Full flexibility in treatment options and accuracy

Choose the right mask system for your patient

- Traditional masks
 - 3- or 5-point RealEase™ masks
 - S-Type masks (head only or head, neck & shoulder)
- Single Shell masks
- Double Shell masks (see also next page)



AC RAD MEDICAL
CONSULT & SERVICE

TRADITIONAL



SINGLE SHELL



DOUBLE SHELL

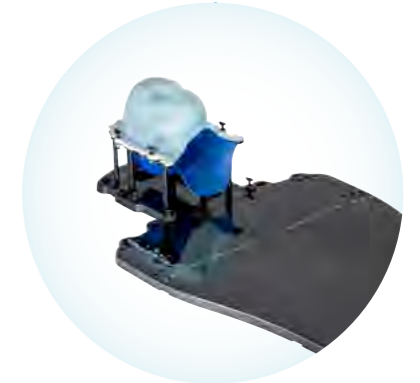

RealEase
or S-Type

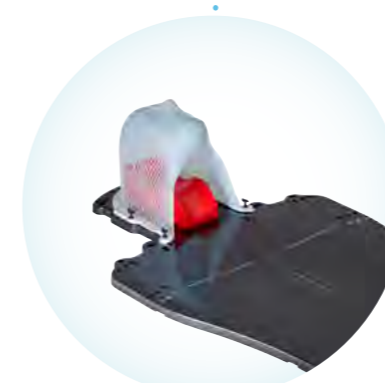

Single Shell and Double Shell masks are also available as head, neck & shoulder masks

DSPS®

Double Shell Positioning System

The MacroMedics® Double Shell Positioning System (DSPS®) strikes the perfect balance among the often competing aspects of patient comfort, accuracy² and throughput. Docking to most common manufacturer's head & neck baseplates, the DSPS concept is created around an ultra-light carbon fiber cradle with low attenuation.

The DSPS system consists of 2 masks made of special thermoplastic materials: The patented material of the occipital mask is rigid enough to hold the patients head during moulding. There is no need for an additional head support and there is full access to customize the mask around neck and occipital bones. The facial mask is not overstretched and therefore extremely rigid. Both masks do not shrink resulting in a comfortable set-up for the patient.

The advanced double shell design enables the clinician to achieve high precision positioning for stereotactic cases, creating a new standard of accuracy² in frameless stereotactic radiosurgery. DSPS is a patented product of MacroMedics.



The cradles are available to fit on most common baseplates, please check for availability.

Features

- Accurate, individually mouldable system (see table)
- Quick and easy patient set-up
- Comfortable² for the patient, also during longer treatments
- Allows fully customized prone positioning
- Different versions available for most common head & neck systems
- MR safe cradles are available



AC RAD MEDICAL
CONSULT & SERVICE

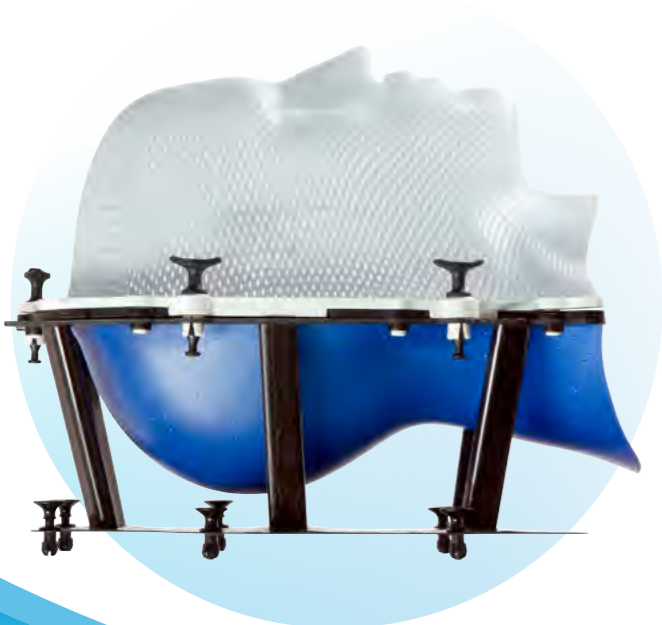

DSPS with masks for prone positioning

Interfractional movement / Set-up correction

	Lat (mm)	Lng (mm)	Vrt (mm)	Pitch (°)	Rtn (°)	Roll (°)
μ	0.1	-0.2	0.4	0.3	0.0	-0.3
Σ	1.1	2.0	2.1	0.5	0.6	0.3
∂	1.1	2.1	4.3	0.5	0.5	0.3

Intrafractional movement

	Lat (mm)	Lng (mm)	Vrt (mm)	Pitch (°)	Rtn (°)	Roll (°)
μ	0.0	0.1	0.0	0.0	0.1	0.0
Σ	0.2	0.1	0.0	0.1	0.2	0.0
∂	0.5	0.2	0.1	0.1	0.3	0.1

μ = mean-of-means Σ systematic ∂ random

Data: MAASTRO Clinic, University Medical Center, Maastricht, The Netherlands²



Head & Neck baseplates

RealEase™ baseplates

MacroMedics® RealEase baseplates are ergonomically shaped for patient comfort. They are indexed on the couchtop with 2 CouchStrips to ensure a reproducible positioning. RealEase profiles with easy to handle plungers offer improved fixation, stability and release of 3- or 5-point masks. Shoulder profiles are anatomically shaped. RealEase baseplates are prepared for attachment of hand grips (optional) to bring the patients shoulders as much as possible out of the treatment area.

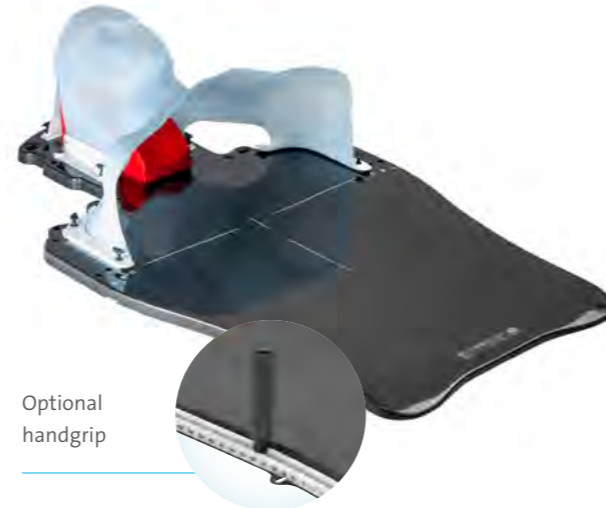

Optional handgrip

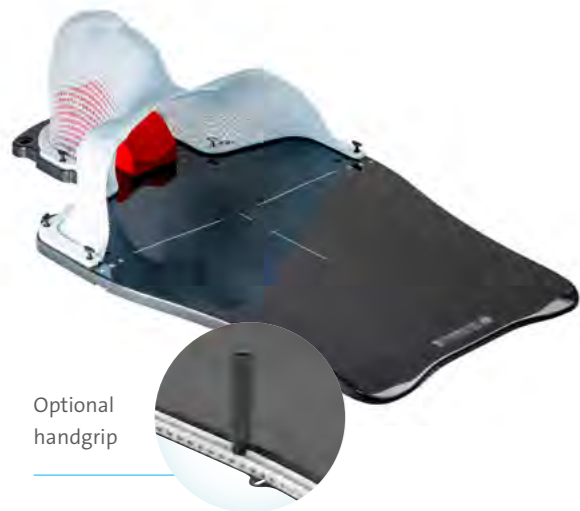

Optional handgrip

S-Type baseplates

MacroMedics® S-Type baseplates are ergonomically shaped for patient comfort. They are indexed on the couchtop with 2 CouchStrips to ensure a reproducible positioning. MacroMedics S-Type baseplates are prepared for attachment of hand grips (optional) to bring the patients shoulders as much as possible out of the treatment area.

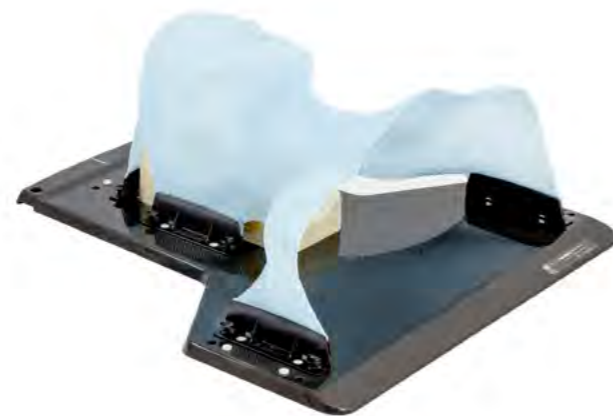

ExaFix™ baseplates

MacroMedics® ExaFix baseplates have a compact design. The ExaFix-3 baseplate is designed for head positioning, the ExaFix-5 baseplate for head, neck & shoulder positioning. Acrylic MR safe versions and pediatric versions of the ExaFix baseplate are available. All ExaFix baseplates can be indexed to the couchtop with a CouchStrip.

IMRT & Tilting baseplates

IMRT baseplates

Intensity Modulated Radiation Therapy requires reliable and accurate high precision patient-set-up. MacroMedics® offers IMRT baseplates specifically designed to support these requirements. The cantilevered design offers a '360 degrees angle of freedom' around the region of interest. The IMRT Baseplates are available for RealEase, S-Type and ExaFix mask systems. They are fit for several types of treatment couches as well as for CT, PET-CT and MR. Please check with us for an overview of available types.



IMRT baseplate for Varian IGRT

IMRT baseplate for Elekta iBEAM® evo

Features

- Better target coverage
- Easily hooked onto cranial end of treatment couch
- Low tolerances in attenuation and dosimetry
- Uniformity on all treatment modalities
- An MR safe version is available

Tilting baseplates

Tilting baseplates are available for RealEase, S-Type and ExaFix mask systems. They can be quickly clicked onto head & neck baseplates and offer angulation of up to 25° or 35° in 5 or 6 steps. Tilting baseplates avoid overstretch of masks as sometimes seen with wedges or blocks. This results in a less overstretched and more stable mask that benefits repositioning.



AC RAD MEDICAL
CONSULT & SERVICE

MaxSupport™

Head supports, blocks and wedges

The MacroMedics® MaxSupport head supports provide stable and comfortable support during treatment in the head- and neck region. The foam MaxSupports are covered with a coating for easy cleaning. The wideshaped MaxSupports nicely fit and support the patients head and offer extra stability on the lateral sides of the head as well as in the neck area. The wideshaped MaxSupports are made of low density foam for minimal attenuation. MaxSupports are also available for prone positioning and in a special version for pediatrics. All foam MaxSupports are MR safe.

For situations where extra stability and reproducibility is desired, MacroMedics developed two sets of carbon fiber MaxSupports. These head supports consists of a very thin layer of carbon fiber combined with a low density foam part for low attenuation. For special treatment requirements low attenuation carbon fiber elevation blocks and wedges are available in various heights and angles.

MaxSupports



MaxSupport Prone



MaxSupports wideshaped



MaxSupport Pediatric



MaxSupports carbon fiber



Carbon fiber wedges

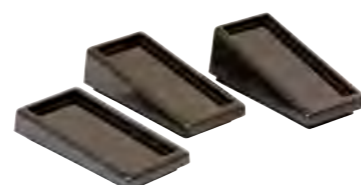

MaxSupports S-line, carbon fiber



Carbon fiber blocks



AC RAD MEDICAL
CONSULT & SERVICE



DSPS® & SSPS®

Thermoplastic masks

For our innovative DSPS and SSPS head and neck positioning systems, MacroMedics® and a leading thermoplastics manufacturer have developed a new generation of thermoplastic masks with unique properties:

- Ray-Pro: the thermoplastic material used for the facial masks, which offers increased rigidity and does not shrink.
- The dark blue Ray-Oc: the only thermoplastic material available on the market to create a mould of the back of the head that holds the patient without the need of an additional head support.

In combination, these thermoplastic masks result in increased patient comfort and improved initial set-up accuracy.²



ExaFix



Type-O



Type-S or RealEase



Open face

2,3 mm thickness, set of 5

DSPS Mask Set for ExaFix (MacroMedics) Supine head and shoulder	114520	DSPS-FSOS
DSPS Mask Set for ExaFix (MacroMedics) Supine head and shoulder for long hair	114570	DSPS-FSOSL
DSPS Mask Set Type-O Supine head and shoulder	114620	DSPS-FSOSO
DSPS Mask Set Type-O Supine head and shoulder for long hair	114670	DSPS-FSOSOL
DSPS Mask Set Type-S or RealEase Supine head and shoulder	114320	DSPS-FSOSS
DSPS Mask Set Type-S or RealEase Supine head and shoulder for long hair	114370	DSPS-FSOSSL
DSPS Mask Set Type-VRT Supine, open face, head and shoulder, S-profiles	114420	DSPS-FSOSVRS
DSPS Mask Set Type-VRT Supine, open face, head and shoulder for long hair, S-profiles	114470	DSPS-FSOSVRL

DSPS®



Supine



Long hair



Open face



Prone

2,3 mm thickness, set of 5

DSPS Mask Set Supine head only	114510	DSPS-FOS
DSPS Mask Set Supine head only for long hair	114560	DSPS-FOSL
DSPS Mask Set Prone head only	114530	DSPS-FOP
DSPS Mask Set Supine head only, Type-VRT, open face	114410	DSPS-FOSVR
DSPS Mask Set Supine head only, Type-VRT, open face, for long hair	114460	DSPS-FOSVRL



SSPS®



2,3 mm thickness, set of 5

SSPS Mask head only	115510	SSPS-F
SSPS Mask head only, Type-VRT, open face	115810	SSPS-FVR

Same as depicted on the previous page for DSPS, only without dark blue occipital mask



2,3 mm thickness, set of 5

SSPS Mask ExaFix head and shoulder	115520	SSPS-FS
SSPS Mask Type-O head and shoulder	115620	SSPS-FSO
SSPS Mask Type-S or RealEase head and shoulder	115720	SSPS-FSS
SSPS Mask Type-VRT Supine, open face, head and shoulder, S-profiles	115820	SSPS-FSVRS

MacroCast™

Thermoplastic masks

MacroCast is a proven thermoplastic material, offering high rigidity, low shrinkage and near transparency while processing the material. MacroCast is available in different perforations, coatings and shapes, with and without profiles attached. The most common types are listed below.

Additional shapes are available, please check with us for details.

RealEase profiles

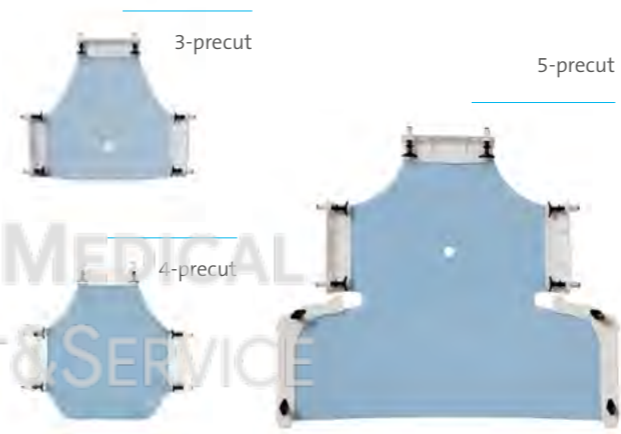

2,3 mm thickness, set of 10

MacroCast fine perfo, 3-precut, RealEase profiles	359530	REMCFC-3
MacroCast fine perfo, comfort, 3-precut, RealEase profiles	357530	REMCFC-3
MacroCast non perfo, 3-precut, RealEase profiles	359730	REMCN-3
MacroCast fine perfo, 4-precut, RealEase profiles	359540	REMCFC-4
MacroCast fine perfo, comfort, 4-precut, RealEase profiles	357540	REMCFC-4
MacroCast non perfo, 4-precut, RealEase profiles	359740	REMCN-4
MacroCast fine perfo, 5-precut, RealEase profiles	359550	REMCFC-5
MacroCast fine perfo, comfort, 5-precut, RealEase profiles	357550	REMCFC-5
MacroCast non perfo, 5-precut, RealEase profiles	359750	REMCN-5

L-profiles

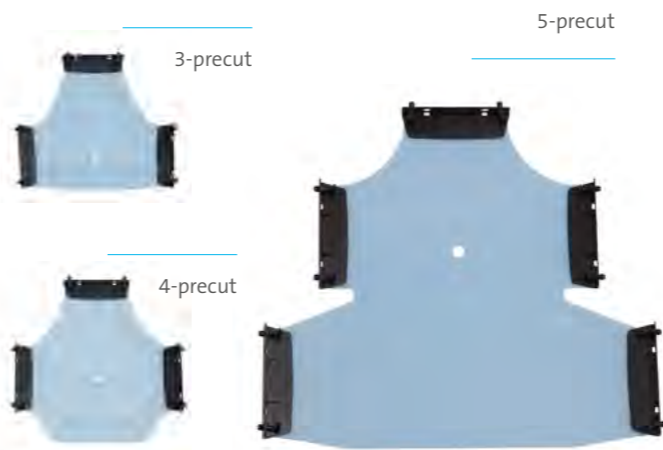

2,3 mm thickness, set of 10

MacroCast fine perfo, 3-precut, L-profiles	119530	LMCF-3
MacroCast fine perfo, comfort, 3-precut, L-profiles	117530	LMCFC-3
MacroCast non perfo, 3-precut, L-profiles	119730	LMCN-3
MacroCast fine perfo, 4-precut, L-profiles	119540	LMCF-4
MacroCast fine perfo, comfort, 4-precut, L-profiles	117540	LMCFC-4
MacroCast non perfo, 4-precut, L-profiles	119740	LMCN-4
MacroCast fine perfo, 5-precut, L-profiles	119550	LMCF-5
MacroCast fine perfo, comfort, 5-precut, L-profiles	117550	LMCFC-5
MacroCast non perfo, 5-precut, L-profiles	119750	LMCN-5



S-Type masks

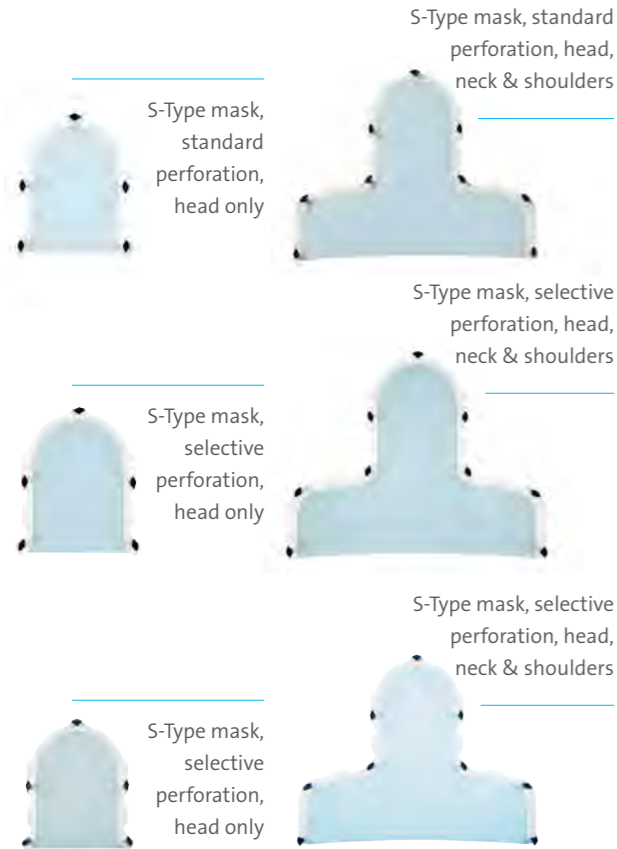

Premium S-Type masks, 2,3 mm, set of 10

S-Type mask, standard perforation, head only	364110	TSS-HO
S-Type mask, standard perforation, head, neck & shoulders	364410	TSS-HNS
S-Type mask, selective perforation, head only	364130	TSRP-HO
S-Type mask, selective perforation, head, neck & shoulders	364430	TSRP-HNS

Premium S-Type masks, 3,0 mm, set of 10

S-Type mask, Premium, 3 mm, multi perforation, head only	363150	TSMP3-HO
S-Type mask, Premium, 3 mm, multi perforation, head, neck and shoulders	363450	TSMP3-HNS
S-Type mask, Premium, 3 mm, selective perforation, head only	363130	TSRP3-HO
S-Type mask, Premium, 3 mm, selective perforation, head, neck and shoulders	363430	TSRP3-HNS
S-Type mask, Premium, 3 mm, non perfo, head only	367110	TSNP3-HO
S-Type mask, Premium, 3 mm, non perfo, head, neck and shoulders	367410	TSNP3-HNS

O-profiles

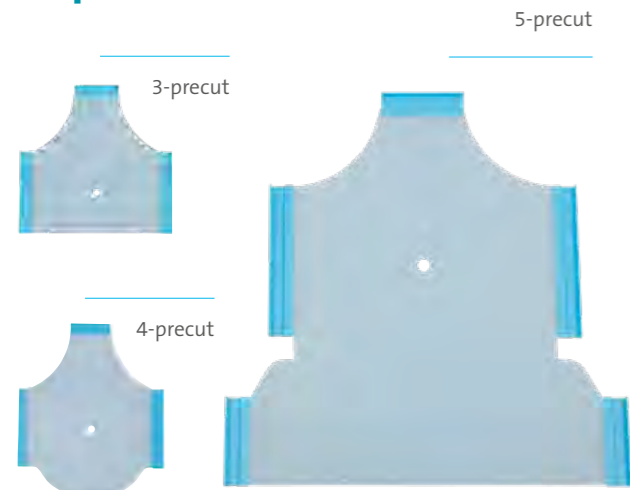

2,3 mm thickness, set of 10

MacroCast fine perfo, 3-precut, O-profiles	129530	OLMCF-3
MacroCast fine perfo, comfort, 3-precut, O-profiles	127530	OLMCFC-3
MacroCast non perfo, 3-precut, O-profiles	129730	OLMCN-3
MacroCast fine perfo, 4-precut, O-profiles	129540	OLMCF-4
MacroCast fine perfo, comfort, 4-precut, O-profiles	127540	OLMCFC-4
MacroCast non perfo, 4-precut, O-profiles	129740	OLMCN-4
MacroCast fine perfo, 5-precut, O-profiles	129550	OLMCF-5
MacroCast fine perfo, comfort, 5-precut, O-profiles	127550	OLMCFC-5
MacroCast non perfo, 5-precut, O-profiles	129750	OLMCN-5

U-frame masks

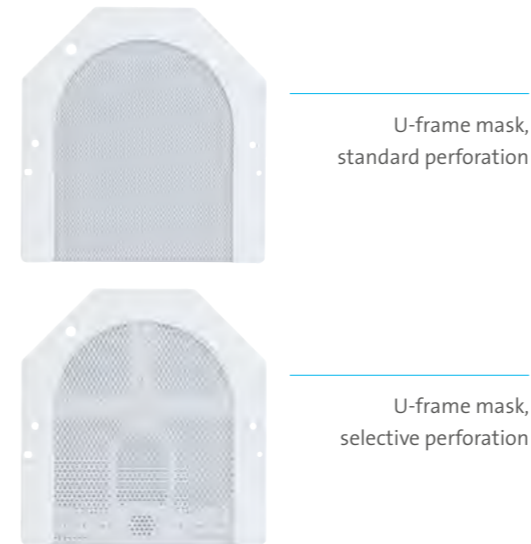

2,3 mm thickness, set of 10

U-Frame mask, standard perforation	376410	TUSS
U-Frame mask, standard perforation, wide	376510	TUSSW
U-Frame mask, standard perforation, neck extension	376480	TUNES
U-Frame mask, selective perforation	373430	TURS

3 mm thickness, set of 10

U-Frame mask, multi perforation	377450	TUSS3
U-Frame mask, multi perforation, wide	377550	TUSSW3
U-Frame mask, multi perforation, neck extension	377480	TUNES3
U-Frame mask, selective perforation	374430	TURS3

MacroBath™

Water bath

AC RAD MEDICAL
CONSULT & SERVICE

The stainless steel MacroBath water bath type 3 has been specifically designed for use with MacroCast™ thermoplastic materials. The MacroBath water bath is electronically controlled and digitally adjustable to ensure the desired temperature for optimal moulding characteristics of MacroCast materials. Available accessories include a MacroBath Trolley which brings the MacroBath to a convenient work position and the EasyGrip™. It assists in an easy and efficient way the handling of 5-points MacroCast masks, allowing them to be removed from the MacroBath by just one person.



MacroBath 3
External dimensions 54 x 66 x 35 cm
(incl handgrips)
Working plane 50.5 x 61 cm
(maximum thermoplastic mask size)



BreastBoard SX™

The BreastBoard SX is the elementary model of the MacroMedics® breast treatment line. It has a straightforward design for quick, easy and efficient patient set-up. It is a cost-effective and modern solution, manufactured to conform with the latest requirements in patient treatment.

The BreastBoard SX provides a coreless single layer carbon fiber treatment zone without grid to obtain low attenuation, maximal homogeneity and rigidity. It is a light and ergonomic breast treatment device securing reproducible day to day patient set-up.

Features

- Rigid, homogeneous and low-attenuation IGRT treatment zone
- Inclination from 5° to 15° in 2.5° steps
- Optional height adjustable arm supports
- Ergonomic and rigid bottomstop
- Optional bottomstop adapter available for shorter patients
- Compatible with 3-point MacroCast™ RealEase™ head masks
- Breast support masks available
- Indexable



BreastBoard LX™

The BreastBoard LX is the premium, stand-alone breastboard. Utilizing a coreless, single-layer carbon fiber treatment zone, the BreastBoard LX provides an IGRT treatment zone with minimal attenuation and maximal homogeneity and stability. The stable, easy to adjust arm supports on the BreastBoard LX address many of the adjustment challenges with other breast board arm supports, providing quick, customizable set-ups for patient comfort and clearance. The BreastBoard LX further addresses common patient comfort issues by incorporating a contoured lumbar area and an optional bottomstop adapter for shorter patients.



Features

- Rigid, homogeneous and low-attenuation IGRT treatment zone
- Inclination from 5° - 20° in 2.5° steps
- Adjustable head support
- Stable and easy to adjust arm supports
- Various arm positions possible with optional accessories: hand grips, high bridge support, 90 degree arm support

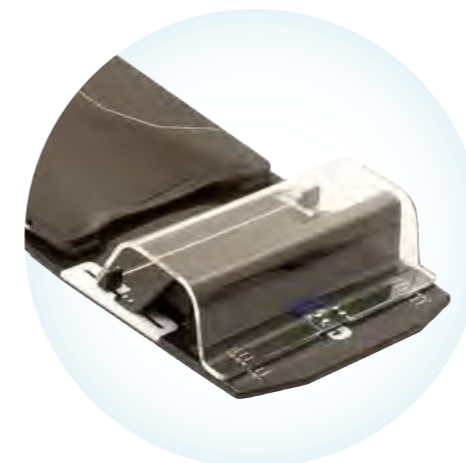

Bottomstop adapter



Handgrips

ThoraxSupport™

The ThoraxSupport is a unique thorax positioning system with maximum focus on treatment set-up, homogeneity, efficiency and patient comfort. It offers versatile and flexible solutions to restrain the patients arms from the treatment area. A short version of the ThoraxSupport is available.

Features

- Stable and easy to adjust arm supports
- Adjustable head support
- Contoured lumbar area for patient comfort
- Compatible with MacroCast™ thorax thermoplastics
- Indexable
- An MR conditional version is available



ThoraxSupport



ThoraxSupport
for MR



ThoraxSupport short

EagleBoard™

The MacroMedics® EagleBoard offers quick and easy patient set-up for treatment of breast, lung and thorax. A variety of indexed supports and grips for head and arms ensure comfortable as well as reproducible set-up for lung and thorax treatments. The EagleBoard provides full support of the upper arms which reduces the need for additional devices such as vacuum cushions.

The tapered design for maximum CT bore clearance and the use of MR safe materials make the EagleBoard an ideal choice for all imaging modalities. The EagleBoard is a compact and cost-effective solution for quick and comfortable patient positioning.

Features

- Tapered design for maximum CT bore clearance
- Easy adjustable positioning of the T- or U-Grip
- Grips can be fixed in two directions for a wide range of positions
- Adjustable, indexed position of MaxSupport 1 head support
- Indexable
- MR safe



EagleBoard T-Grip

EagleBoard U-Grip

AC RAD MEDICAL
CONSULT&SERVICE

KneeSupport™

KneeSupports are used to raise the patient's legs, flattening the lumbar spine to support a comfortable position for the patient.

MacroMedics offers 3 different types of KneeSupports:

- A lightweight foam version with a smooth coating for easy cleaning.
- A durable plastic version with an integrated handgrip
- A low plastic version for paediatric, small or elderly patients

All KneeSupports can be indexed directly on the couchtop and can be placed in 4 different positions.

KneeSupport foam



KneeSupport plastic



KneeSupport plastic, low

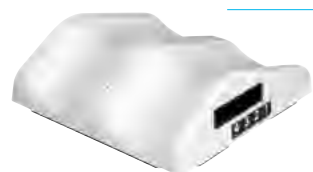

To further lift the knees of tall patients or patients with greater spine curvature, KneeSupport LiftBlocks can be placed underneath the KneeSupports, offering an additional elevation of 5 cm.

KneeSupport LiftBlock



FeetSupport™

When lying in a relaxed position, feet naturally point outward. The FeetSupport places the patient's feet in this natural position for comfort and to assist stabilising the patient set-up. The FeetSupport cushions have a smooth coating for easy cleaning.

There are two types of FeetSupport:

- Fixed FeetSupport which hold the feet at a set angle
- Rotatable FeetSupport which can be indexed directly on the couchtop and allow the feet to be positioned at 4 different indexed angles

FeetSupport



FeetSupport rotatable



FeetSupport fixed



AC RAD MEDICAL
CONSULT & SERVICE

LEPS™

The MacroMedics® Lower Extremity Positioning System (LEPS) is a modular solution that supports the comfortable positioning of the patient's pelvic region and lower extremities. The system consists of a lightweight baseplate which provides indexed positions for KneeSupport™, LiftBlock™ and FeetSupport™. The system can be upgraded with an optional shoulder retractor.

New

A compact short version of the LEPS baseplate which allows indexing of the FeetSupport in small increments. It can be used, for example, in combination with the MultiBoard or BreastBoard.

Features

- Indexed positions:
 - KneeSupport in 4 steps
 - FeetSupport in 11 steps
- Upgrade with an optional shoulder retractor
- Indexable
- The LEPS is MR conditional

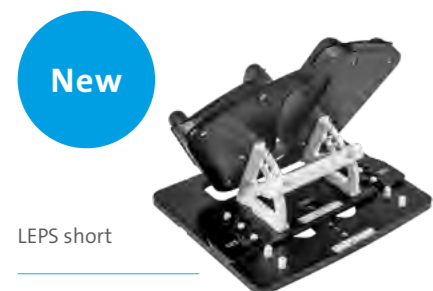

Pelvic Prone Board™

The MacroMedics® Pelvic Prone Board is an anatomically shaped prone positioning device for patients undergoing treatment in the pelvic region. It offers a patient friendly, comfortable design. An optional indexed Pron Pillo helps to further increase patient support and set-up reproducibility. The Pelvic Prone Board is lightweight, rigid and indexable. The region of interest (R.O.I.) consists of a specifically designed low attenuation carbon fiber sandwich construction with optimized dosimetric properties¹ to allow 'arc' techniques. With the Pelvic Prone Board, it is possible to obtain a significant reduction of the irradiated small bowel volume.³

Features

- Special carbon fiber sandwich construction in R.O.I. for optimal dosimetry for arc techniques
- Integrated arm rests for patient comfort
- Optional indexable Pron Pillo
- Indexable
- An MR safe version is available



Lex-Ultra™

The LEX-Ultra is a user friendly solution that provides support in positioning of the lower extremities. The LEX-Ultra is designed to create unobstructed radiation beam access in the region of interest (R.O.I.) and allows to position the unaffected extremity out of the treatment area. The low density baseplate in combination with carbon fiber elements in the lower leg region provides an adjustable, flexible and easy to use support and creates optimal positioning of the treated extremity.

Features

- A lightweight baseplate
- Individual leg supports, height-adjustable in 6 indexed positions
- Optional middle block to position upper legs
- Integrated fixation points for various thermoplastic masks
- Indexable
- An MR safe version is available



UniqFix™

The UniqFix is a multifunctional carbon fiber baseplate, offering countless possibilities for the positioning of extremities. Dedicated thermoplastic mask shapes have been designed for positioning of arms, hands, legs and feet in straight or bent position. The UniqFix can be indexed on the couchtop in two perpendicular directions, allowing for arm positioning extended from the couchtop.

Features

- Multifunctional baseplate
- Various thermoplastics available for extremity positioning
- Indexable
- An MR safe version is available

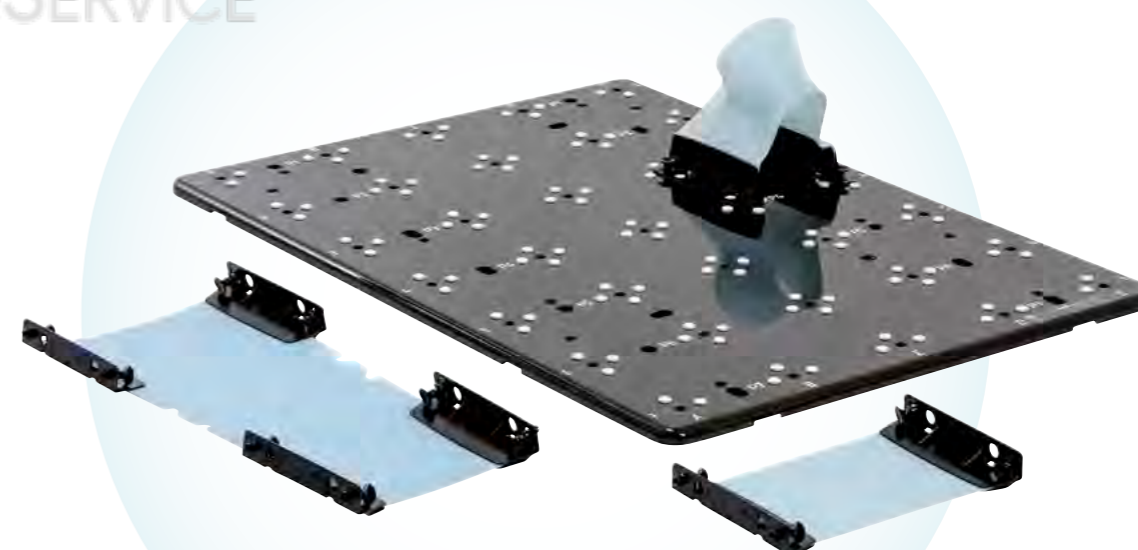

AC RAD MEDICAL
CONSULT&SERVICE

Couchtops

To overcome the problems caused by the difference in geometry between concave scanner couchtops and flat simulator and linear accelerator couchtops MacroMedics® offers lightweight removable couchtops for various types of scanners. All MacroMedics couchtops simply lock onto the cradle of the scanner with a clamping mechanism which allows the couchtop to be easily removed at any time. As all carbon fiber MacroMedics products, the diagnostic couchtops are developed and produced with state of the art 3-D molding- and production techniques. Different indexing options are available.

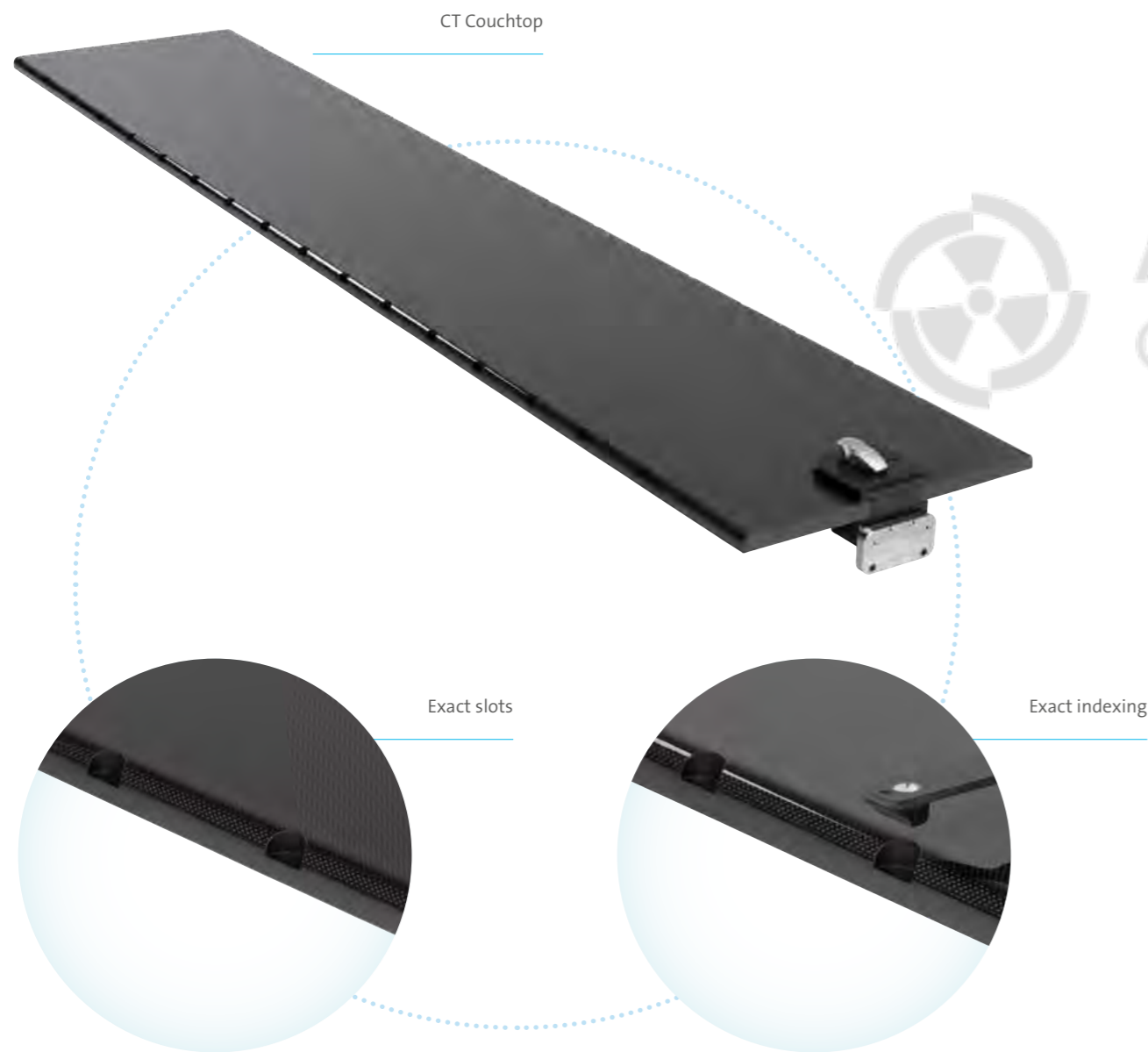

CouchStrips™

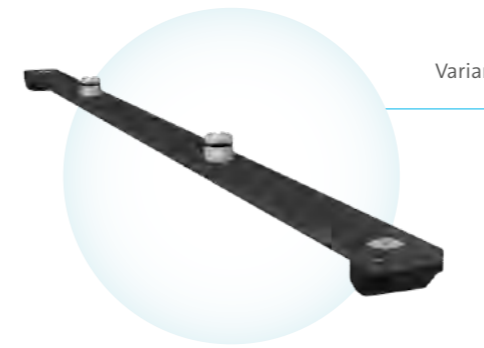

Varian

Exact CouchStrip Fixed 530	147960	CF
Exact CouchStrip Fixed 500	147950	CF
Exact CouchStrip Fixed 530	147930	GF for MR

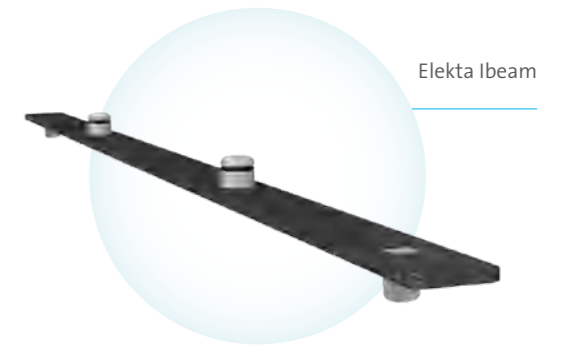

Elekta Ibeam

Ibeam CouchStrip Fixed 530	147110	CF
----------------------------	--------	----

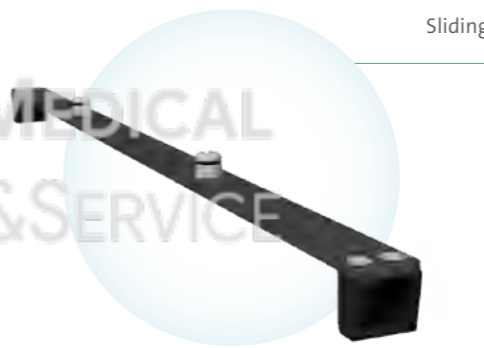

Sliding

CouchStrip Fixed 530, Sliding sidepieces	147130	CF
CouchStrip Fixed 500, Sliding sidepieces	147140	CF
CouchStrip Fixed 530, Sliding sidepieces	147150	GF for MR

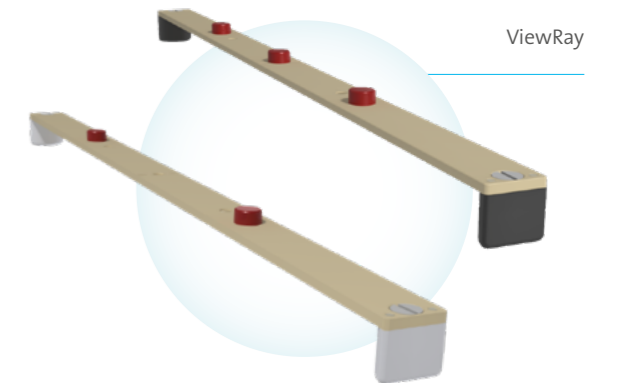

ViewRay

MRIdian 3-pin Rail Cranial	164180	
MRIdian 2-pin Rail	164170	



VBCS CF

Vacuum bag positioning Strip	155870	CF
------------------------------	--------	----

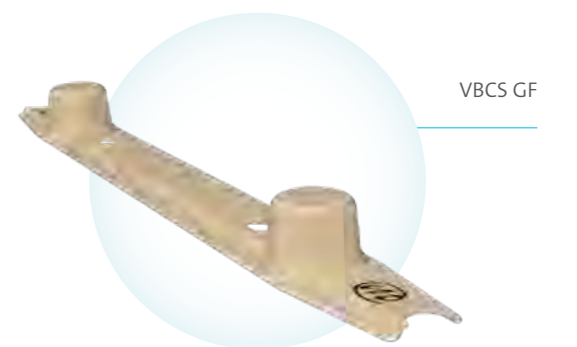

VBCS GF

Vacuum bag positioning strip	155950	GF for MR
------------------------------	--------	-----------

Vacuum cushions

MacroMedics® vacuum cushions are manufactured from durable and easy to clean materials. They have an easy-to-use valve that does not leak. The vacuum cushions can be easily indexed on the couchtop with a carbon fiber vacuum cushion positioning strip. To mould the vacuum cushions, a basic single function pump and a dual function pump are available. The dual function pump offers a wireless hand or foot remote control for quick adjustment during moulding. It can be carried easily as it is compact and battery operated.

Features

- Durable, high-quality polyamide
- Blue colour distinguishable in optical imagers
- Radiotranslucent
- Cost-effective
- MR conditional
- Adapters available for pumps with CPC connector



ExaFlex™ and thermoplastic bolus

ExaFlex is a flexible, homogeneous bolus material that conforms nicely to the patient anatomical contours. ExaFlex is made from a tissue-equivalent gel with a density of 1.03 g/cm. It is available in various sizes and thicknesses and can be cut with a pair of scissors to fit the patients contours. ExaFlex can be build up in layers when required to obtain the desired build-up thickness.

ExaFlex is available in an easy to clean version with skin or a skinless version that will stick to the patients contours and allow stacking.

ExaFlex is calibrated with photon and electrons beams in the energy range of more than 1 MeV. ExaFlex is 100% latex free.

MacroMedics® also offers thermoplastic bolus which can be custom-moulded to the patients anatomy.

AC RAD MEDICAL
CONSULT & SERVICE

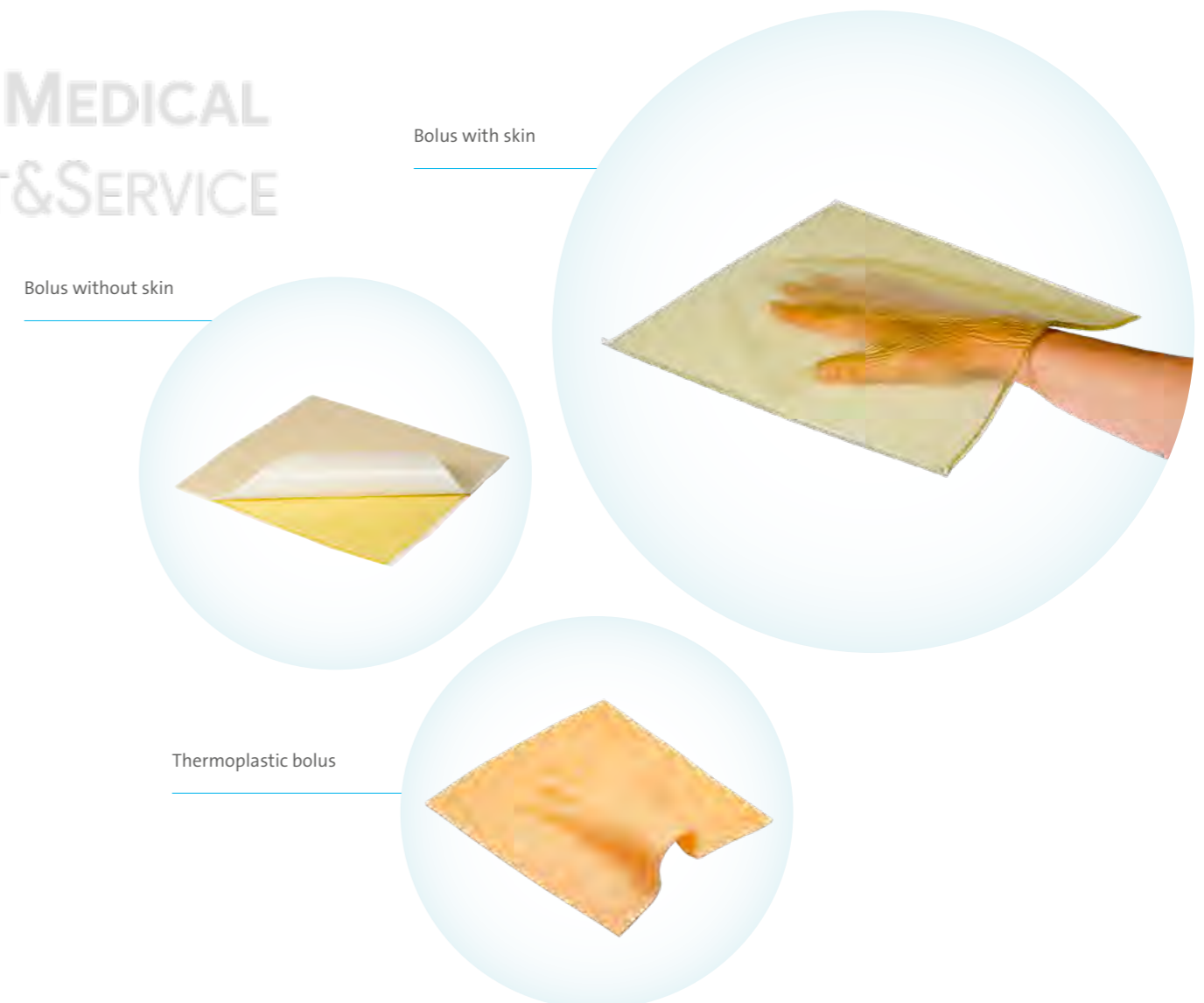

Products for use in MR

MR imaging in radiotherapy is becoming more important and is showing an increasing value in the patient treatment processes. MacroMedics® has developed a whole range of MR safe and MR conditional products for various treatment areas that provide the same product settings between all diagnostic and treatment modalities.

DSPS® and SSPS® cradles are available in MR safe versions.

A few samples of our product range for MR imaging are shown below, please check with your distributor for the full range available.



MaxSupports, glass fiber, MR safe



Elevation blocks, glass fiber, MR safe



Wedges, glass fiber, MR safe



DSPS cradle, MR safe



EagleBoard, MR safe

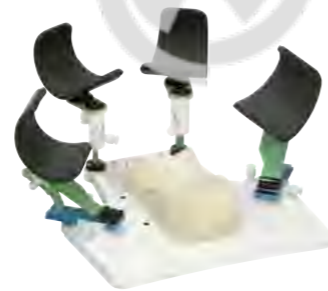

ThoraxSupport Short, MR conditional



Exatilt, MR safe



Pelvic Prone Board, MR safe



LEPS, MR conditional

Product list

DSCP

OmniCouch, OmniBoard, MultiBoard - Pages 8 - 22

Many different options are available for these products. Please contact your distributor for further information.

FluxBoard - Page 23

FluxBoard package for ViewRay MRIdian, 3P	164100	UTBM-FB
FluxBoard package for CT, 3P	164150	UTBM-FBCT
FluxBoard Head & Neck Module, 3P package	164200	UTBM-HNM

EAMIS Lite - Page 24

EAMIS Lite system, carbon fiber, 2P	123800	EA-LITE
EAMIS Lite system, MR safe, 3P	123850	EA-LITE-MR

DSCP Accessories - See pages 26 - 27

Head & Neck

SSPS Cradles - Page 30

SSPS Cradle for RealEase systems	111120	SSPS-CHRE
SSPS cradle for S-Type systems	111520	SSPS-CHS
SSPS Cradle for ExaFix systems	111620	SSPS-CHE
SSPS Cradle for Type-O systems	111600	SSPS-CHO

DSPS Cradles - Page 32

DSPS Cradle Type MacroMedics ExaFix	112710	DSPS-CTMH
DSPS Cradle Type MacroMedics RealEase	171210	DSPS-CTMHRE
DSPS Cradle Type-O	112720	DSPS-CTOH
DSPS Cradle Type-S	112730	DSPS-CTSH
DSPS Cradle Type-VRT	112740	DSPS-CTVRH
DSPS Cradle Type-B	112750	DSPS-CTBH
DSPS Cradle Type-I	112760	DSPS-CTIH
DSPS Cradle Type-U	112770	DSPS-CTUH
DSPS Cradle Type-V	112780	DSPS-CTVH
DSPS Cradle Type-QA	112790	DSPS-CTQAH

MR safe versions of SSPS and DSPS cradles are available. Please contact your distributor for further information.

Baseplates - Page 34

RealEase baseplate, 2P	111300	SSPS-BMRE
S-Type baseplate, 2P	111400	SSPS-BTS
Handgrips for shoulder retraction for use with RealEase or S-Type baseplate, set of 2	111230	SSPS-HG
ExaFix-3, carbon fiber baseplate, 3-point fixation, 2P	110120	EXF-3
ExaFix-3A, acrylic baseplate, 3-point fixation, 3P, MR safe	110160	EXF-3A
ExaFix-5, carbon fiber baseplate, 5-point fixation, 2P	110100	EXF-5
ExaFix-5A, acrylic baseplate, 5-point fixation, 3P, MR safe	110140	EXF-5A
ExaFix Pediatric, carbon fiber baseplate, 5-point fixation, 2P	110250	EXF-PED

Contact your local distributor for availability of the products in your country.



Tilting Baseplates - Page 35

HeadTilt for RealEase systems, 25 degrees	171500	RE-EXT
HeadTilt for RealEase systems, 25 degrees, MR safe	171520	RE-EXTMR
HeadTilt for S-Type systems, 25 degrees	171560	S-HT25
HeadTilt for S-Type systems, 25 degrees, MR safe	171570	S-HT25MR
ExaTilt, 25 degrees	110200	EXT
ExaTilt, 35 degrees	110230	EXT35
ExaTilt, 25 degrees, MR safe	110240	EXTMR

MaxSupports - Page 36

MaxSupports, set of 3	117100	HSSET
MaxSupports wideshaped, set of 3	117000	HSSETW
Set of MaxSupports carbon fiber, 3	117105	HSSETCF
MaxSupport S-Line, carbon fiber, set of 4	116350	HS-SSET
MaxSupport S-Line for other manufacturers S-Type, carbon fiber, set of 4	116550	HS-BSSET
MaxSupport Prone	116940	HSP
MaxSupport Pediatric Supine	116950	HSPS
Carbon fiber wedges for ExaFix, set of 3 (5, 10 and 15 degrees)	110500	CFWSET
Carbon fiber elevation blocks for ExaFix, set of 2	110580	CFBSET
Carbon fiber wedge for ExaFix, 7 degrees (for hyperextension)	110540	CFW7
Carbon fiber wedges for RealEase, set of 3 (5, 10 and 15 degrees)	171600	RE-CFWSET
Carbon fiber elevation blocks for RealEase, set of 2	171680	RE-CFBSET
Carbon fiber wedge for RealEase, 7 degrees (for hyperextension)	171640	RE-CFW7

MR safe versions of MaxSupports and blocks & wedges are available. Please contact your distributor for further information.

Thermoplastic Masks

Thermoplastic Masks for DSPS / SSPS and MacroCast - See pages 38 - 43

Accessories for thermoplastic masks - Page 43

MacroBath3 for thermoplastic masks, max. mask size 50,5x61cm 230 V	154300	WB3
EasyGrip, for handling of ExaFix head, neck and shoulder masks	154500	WBEG
MacroBath Trolley	154600	WBTR

Breast & Thorax

BreastBoard SX - Page 44

BreastBoard SX with rigid arm supports	172400	MBSXR
BreastBoard SX with height adjustable arm support	172450	MBSXA
Bottomstop adaption for shorter patients	122590	BSS

BreastBoard LX - Page 45

BreastBoard LX	122500	MBLXI
BreastBoard LX, MR conditional	122750	MBLXIMR
High bridge support for lower arms	122540	HBSBT
90 degree arm support, set of 2	122670	90BT
Handgrips, set of 2	122730	HGBT2
Bottomstop adaption for shorter patients	122590	BSS

Contact your local distributor for availability of the products in your country.

ThoraxSupport - Page 46

ThoraxSupport	122100	LB1C
ThoraxSupport, MR safe	122150	LB1MR
ThoraxSupport Short	122650	LB1CS
ThoraxSupport Short, MR Safe	122660	LB1MRS
High bridge support for lower arms	122540	HBSBT
90 degree arm support, set of 2	122670	90BT
Handgrips, set of 2	122730	HGBT2

EagleBoard - Page 47

EagleBoard, 3P, MR safe including T- and U-Grip	122800	EBTU
EagleBoard, 3P, MR safe including T-Grip	122810	EBT
EagleBoard, 3P, MR safe including U-Grip	122820	EBU

Pelvic, Abdomen & Extremities

KneeSupport - Page 48

KneeSupport, coated, 3P	130100	KS
KneeSupport, plastic, 3P	130140	KSP
KneeSupport low, plastic, 3P	130130	KSPL
KneeSupport LiftBlock, 3P	130120	KCB

FeetSupport - Page 49

FeetSupport, rotatable, 3P	130260	FSTS
FeetSupport, fixed, indexable on LEPS and DSCP platforms, 3P	130250	FSTSF

LEPS - Page 50

LEPS System, with adjustable FeetSupport, MR conditional	130300	LEPS
LEPS System, with fixed FeetSupport, MR conditional	130310	LEPSF
Shoulder retractor for use with LEPS	130350	SHRT
Lower Extremity Positioning System, baseplate, short, 3P	130420	LEPSBPS

Pelvic Prone Board - Page 51

Pelvic Prone Board, carbon fiber, with small prone cushion	130600	PPBCSPC
Pelvic Prone Board, glass fiber, with small prone cushion, MR safe	130650	PPBGSPC
Indexable Pron Pillo for the Pelvic Prone Board	116850	PPBB

LEX Ultra - Page 52

LEX Ultra positioning device for lower extremities	132100	LEXU
LEX Ultra MR safe	132150	LEXMR

UniqFix - Page 53

UniqFix positioning system for extremities, carbon fiber	135100	UNIQCFC
UniqFix positioning system for extremities, MR safe	135150	UNIQCFCMR

Contact your local distributor for availability of the products in your country.

Miscellaneous

Couchtops - Page 54

CouchStrips - Page 55

There are various different CouchStrips and side pieces. To find the right solution for your couchtop, please contact your local distributor.

Vacuum cushions - Page 56

Vacuum cushion, head support, 30x40cm 3L	155110	VHS3040
Vacuum cushion, head support, 25x50cm 3L	155140	VHS2550
Vacuum cushion, head & shoulder support, T-shape, 50x70cm 5L	155150	VHSS5070T
Vacuum cushion, breast support, 50x70cm 8L	155210	VBR55070
Vacuum cushion, pelvic support, 65x65cm 13L	155300	VPS6565
Vacuum cushion, body support, 100x70cm 30L	155400	VBOS10070
Vacuum cushion, body support, 100x80cm 30L	155410	VBOS10080
Vacuum cushion, body support, 120x80cm 36L	155430	VBOS12080
Vacuum cushion, body support, 100x150cm 51L	155450	VBOS100150
Vacuum cushion, body support, 200x100cm 85L	155510	VBOS200100
Vacuum cushion, body support, T-shape 120x120cm 45L	155520	VBOS120120T
Vacuum cushion positioning strip	155870	VCPS
Single function Vacuum Pump, 230 V	155800	VP
Dual function Vacuum Pump, incl. tube and connector, 230 V	155810	VPF
Quick inflation connector with 2m tube	155900	VQIC2
Quick inflation connector with 2m tube and CPC connector	155920	VQIC2CPC

ExaFlex & thermoplastic bolus - Page 57

ExaFlex 15x15x1,0 cm with skin	153170	BS151510
ExaFlex 15x15x0,5 cm with skin	153180	BS151505
ExaFlex 30x30x1,0 cm with skin	153110	BS303010
ExaFlex 30x30x0,5 cm with skin	153120	BS303005
ExaFlex 40x40x1,0 cm with skin	153130	BS404010
ExaFlex 40x40x0,5 cm with skin	153140	BS404005
ExaFlex 50x50x1,0 cm with skin	153150	BS505010
ExaFlex 50x50x0,5 cm with skin	153160	BS505005
ExaFlex 30x30x1,0 cm without skin	153310	B303010
ExaFlex 30x30x0,5 cm without skin	153320	B303005
ExaFlex 40x40x1,0 cm without skin	153330	B404010
ExaFlex 50x50x1,0 cm without skin	153350	B505010
ExaFlex 50x50x0,5 cm without skin	153360	B505005
MacroCast non perfo plate 3,2 mm, 30x30 cm	153210	BMCN32
MacroCast non perfo plate 5 mm, 30x30 cm	153220	BMCN48

Products for use in MR - Page 58

We offer MR safe or MR conditional versions for most of our products. Please contact your distributor for further information.

Contact your local distributor for availability of the products in your country.



Contact MacroMedics® or your local distributor for detailed information or an on-site product demonstration.

MacroMedics, SSPS and DSPS are registered trademarks of MacroMedics BV.

All other trademarks are property of their respective owners.

DSPS is a patented system in US (US 9,808,648), with a patent pending in Europe (EP16184729.8).



References

- 1 Dosimetric properties of MacroMedics products have been measured and are available on the MacroMedics website.
- 2 Data on DSPS accuracy and comfort:
 - EP-1506: Evaluation of cranial setup accuracy: a double shell positioning system versus an in-house 3-point mask solution Van der Meer, S. et al. Radiotherapy and Oncology, Volume 115, S819 - S820
 - OC-0077: Comparison of setup accuracy, intrafraction movement and comfort for two stereotactic masks Meunier, C. et al. Radiotherapy and Oncology, Volume 123, S40. This data is available for download on the MacroMedics® website.
- 3 Reduction of irradiated small bowel volume and accurate patient positioning by use of a bellyboard device in pelvic radiotherapy of gynecological cancer patients Olofsen-van Acht, Manouk et al. Radiotherapy and Oncology, Volume 59, Issue 1, 87 - 93 Systematic review of the role of a belly board device in radiotherapy delivery in patients with pelvic malignancies Wiesendanger-Wittmer, Esther M. et al. Radiotherapy and Oncology, Volume 102, Issue 3, 325 - 334.

Version: 6.1, 2020

Document number: MM2





macromedics
SOLUTIONS IN RADIOTHERAPY

MacroMedics BV

Kouwe Hoek 18
2741 PX Waddinxveen
The Netherlands

T +31(0)182 38 97 77

F +31(0)182 38 97 78

info@macromedics.com

www.macromedics.com

Your distributor

AC RAD MEDICAL
CONSULT & SERVICE